



European Organisation for Astronomical Research in the Southern Hemisphere

**Programme:** GEN

**Project/WP:** Science Operation Software Department

# CRIRES+ Reflex Tutorial

**Document Number:** ESO-413897

**Document Version:** 1.6.13

**Document Type:** Manual (MAN)

**Released on:** 2026-06-17

**Document Classification:** Public

Prepared by: CRIRES+ Pipeline Team

Validated by:

Approved by:

Name

This page was intentionally left blank



## Authors

Name	Affiliation
Thomas Marquart	Uppsala University
Yves Jung	ESO
Valentin Ivanov	ESO

This page was intentionally left blank



## Change Record from previous Version

Affected Section(s)	Changes/Reason/Remarks
All	First Version
1.2.2	Additional workflows and demo data

This page was intentionally left blank



## Contents

<b>1</b>	<b>Introduction to <code>Esoreflex</code></b>	<b>9</b>
<b>2</b>	<b>Software Installation</b>	<b>10</b>
2.1	Installing <code>Esoreflex</code> workflows via <code>macports</code> . . . . .	10
2.2	Installing <code>Esoreflex</code> workflows via <code>rpm/yum/dnf</code> . . . . .	10
2.3	Installing <code>Esoreflex</code> workflows via <code>install_esoreflex</code> . . . . .	10
<b>3</b>	<b>Quick Start: Reducing The Demo Data</b>	<b>12</b>
<b>4</b>	<b>The CRIRES+ Workflow</b>	<b>15</b>
4.1	Workflow Canvas Parameters . . . . .	15
<b>5</b>	<b>About the main <code>esoreflex</code> canvas</b>	<b>17</b>
5.1	Saving And Loading Workflows . . . . .	17
5.2	Buttons . . . . .	17
5.3	Workflow States . . . . .	17
5.4	Workflow Actors . . . . .	18
5.4.1	Simple Actors . . . . .	18
5.4.2	Lazy Mode . . . . .	18
<b>6</b>	<b>Frequently Asked Questions</b>	<b>20</b>
<b>7</b>	<b>Troubleshooting</b>	<b>23</b>



## CRIRES+ Reflex Tutorial

Doc. Number: ESO-413897  
Doc. Version: 1.6.13  
Released on: 2026-06-17  
Page: 8 of 25

---



## 1 Introduction to `EsoReflex`

This document is a tutorial designed to enable the user to to reduce his/her data with the ESO pipeline run under an user-friendly environmet, called `EsoReflex`, concentrating on high-level issues such as data reduction quality and signal-to-noise (S/N) optimisation.

`EsoReflex` is the ESO Recipe Flexible Execution Workbench, an environment to run ESO VLT pipelines which employs a workflow engine to provide a real-time visual representation of a data reduction cascade, called a workflow, which can be easily understood by most astronomers. The basic philosophy and concepts of Reflex have been discussed by [Freudling et al. \(2013A&A...559A..96F\)](#). Please reference this article if you use Reflex in a scientific publication.

Reflex and the data reduction workflows have been developed by ESO and instrument consortia and they are fully supported. If you have any issue, please have a look to <https://support.eso.org> to see if this has been reported before or [open a ticket](#) for further support.

A workflow accepts science and calibration data, as downloaded from the archive using the CalSelector tool<sup>1</sup> (with associated raw calibrations) and organises them into DataSets, where each DataSet contains one science object observation (possibly consisting of several science files) and all associated raw and static calibrations required for a successful data reduction. The data organisation process is fully automatic, which is a major time-saving feature provided by the software. The DataSets selected by the user for reduction are fed to the workflow which executes the relevant pipeline recipes (or stages) in the correct order. Full control of the various recipe parameters is available within the workflow, and the workflow deals automatically with optional recipe inputs via built-in conditional branches. Additionally, the workflow stores the reduced final data products in a logically organised directory structure employing user-configurable file names.

The workflow follows the "simple way" of reducing calibrations from the CRIRES+ Pipeline User Manual. That is it makes use of the TW-table from the CalibDB and runs a single recipe for each of: darks, flats, wavecal and science reduction.

---

<sup>1</sup> <https://www.eso.org/sci/archive/calselectorInfo.html>



## 2 Software Installation

`Esoreflex` and the workflows can be installed in different ways: via package repositories, via the `install_esoreflex` script or manually installing the software tar files.

The recommended way is to use the package repositories if your operating system is supported. The pipelines and Reflex can be installed from the ESO `macports` repositories that support macOS platforms, the and the `rpm/yum` repositories that support Fedora and CentOS platforms. For any other operating system it is recommended to use the `install_esoreflex` script.

The installation from package repository requires administrative privileges (typically granted via `sudo`), as it installs files in system-wide directories under the control of the package manager. If you want a local installation, or you do not have `sudo` privileges, or if you want to manage different installations on different directories, then use the `install_esoreflex` script. Note that the script installation requires that your system fulfill several software prerequisites, which might also need `sudo` privileges.

Reflex 2.11.x needs java JDK 11 to be installed.

Please note that in case of major or minor (affecting the first two digit numbers) Reflex upgrades, the user should erase the `$HOME/KeplerData`, `$HOME/.kepler` directories if present, to prevent possible aborts (i.e. a hard crash) of the `esoreflex` process.

### 2.1 Installing `Esoreflex` workflows via `macports`

This method is supported for the macOS operating system. It is assumed that `macports` (<https://www.macports.org>) is installed. Please read the full documentation at <https://www.eso.org/sci/software/pipelines/installation/macports.html>, which also describes the versions of macOS that are currently supported.

### 2.2 Installing `Esoreflex` workflows via `rpm/yum/dnf`

This method is supported for Fedora and CentOS platforms and requires `sudo` rights. Please read the full documentation at <https://www.eso.org/sci/software/pipelines/installation/rpm.html>, which also describes the versions of Fedora and CentOS that are currently supported.

### 2.3 Installing `Esoreflex` workflows via `install_esoreflex`

This method is recommended for operating systems other than what indicated above, or if the user has no `sudo` rights. Software dependencies are not fulfilled by the installation script, therefore the user has to install all the prerequisites before running the installation script.

The software pre-requisites for Reflex 2.11.0 may be found at: [https://www.eso.org/sci/software/pipelines/reflex\\_workflows](https://www.eso.org/sci/software/pipelines/reflex_workflows)

To install the Reflex 2.11.0 software and demo data, please follow these instructions:



1. From any directory, download the installation script:

```
wget https://eso.org/sci/software/pipelines/install_esoreflex
```

2. Make the installation script executable:

```
chmod u+x install_esoreflex
```

3. Execute the installation script:

```
./install_esoreflex
```

and the script will ask you to specify three directories: the download directory `<download_dir>`, the software installation directory `<install_dir>`, and the directory to be used to store the demo data `<data_dir>`. If you do not specify these directories, then the installation script will create them in the current directory with default names.

4. Follow all the script instructions; you will be asked whether to use your Internet connection (recommended: yes), the pipelines and demo-datasets to install (note that the installation will remove all previously installed pipelines that are found in the same installation directory).
5. To start `Reflex`, issue the command:

```
<install_dir>/bin/esoreflex
```

It may also be desirable to set up an alias command for starting the `Reflex` software, using the shell command `alias`. Alternatively, the `PATH` variable can be updated to contain the `<install_dir>/bin` directory.

### 3 Quick Start: Reducing The Demo Data

The content of demo data sets are described in Table 3. Digits in the brackets give the number of raw frames of the given type. Some calibration files are shared among multiple datasets.

Mode	OBS.TARG.NAME	INS.WLEN.ID	Science frames	Calib frames
2d	gam Gru	K2192	object (2), sky (2)	flat (1), dark (2), UNe lamp (1), FPET (1)
stare	HD 201585	K2166	object (1)	flat (1), dark (3), UNe lamp (1), FPET (1)
nodding	CD-40 9712	K2192	object (2)	flat (1), dark (3), UNe lamp (1), FPET (1)
nodding	HD 222925	K2192	object (2)	flat (1), dark (2), UNe lamp (1), FPET (1)
nodding	HD 222925	Y1028	object (2)	flat (1), dark (3), UNe lamp (1), FPET (1)
nodding	alf Eri	L3262	object (2)	flat (1), dark (1)
polarim.	eps CMa	K2192	object (8)	flat (1), dark (3), UNe lamp (1), FPET (1)

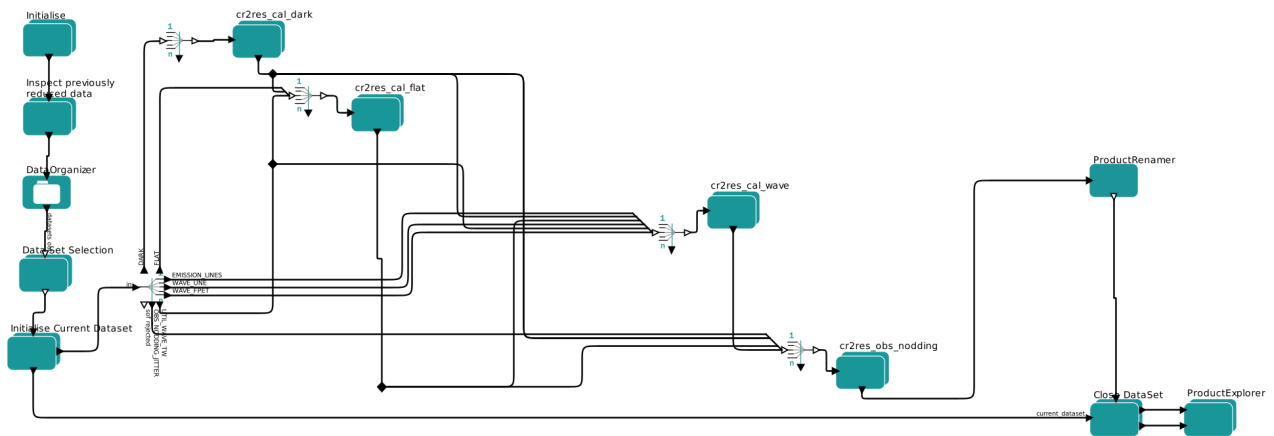

Figure 3.1: Screenshot of the nodding workflow.

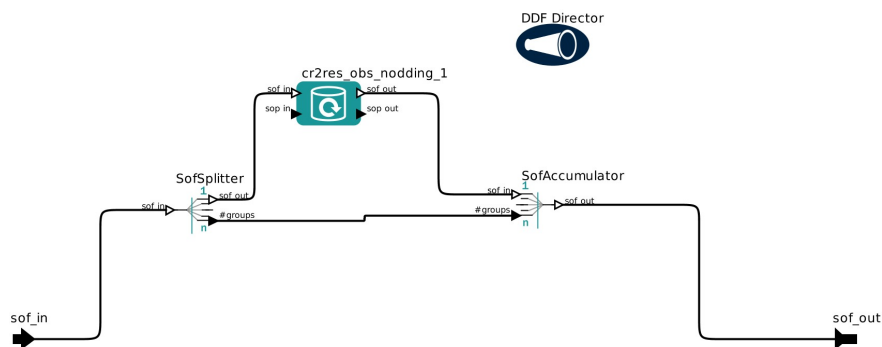

Figure 3.2: Screenshot of the expansion of the nodding-recipe box.

Fig. 3.1 and 3.2 show the nodding data workflow and the sub-workflow that actually calls the nodding recipe, respectively. The counterpart workflows for the other observing modes are identical, except for the names of the corresponding science recipe.



For the user who is keen on starting reductions without being distracted by detailed documentation, we describe the steps to be performed to reduce the science data provided in the CRIRES+ demo data set supplied with the `esoreflex 2.11.0` release. By following these steps, the user should have enough information to perform a reduction of his/her own data without any further reading:

1. First, type:

```
esoreflex -l
```

If the `esoreflex` executable is not in your path, then you have to provide the command with the executable full path `<install_dir>/bin/esoreflex -l`. For convenience, we will drop the reference to `<install_dir>`. A list with the available `esoreflex` workflows will appear, showing the workflow names and their full path.

2. Open the CRIRES+ by typing:

```
esoreflex crires+&
```

Alternatively, you can type only the command `esoreflex` the empty canvas will appear (Figure 3.3) and you can select the workflow to open by clicking on `File -> Open File`. Note that the loaded workflow will appear in a new window. The CRIRES+ workflow is shown in Figure 3.1.

3. To aid in the visual tracking of the reduction cascade, it is advisable to use component (or actor) highlighting. Click on `Tools -> Animate at Runtime`, enter the number of milliseconds representing the animation interval (100 ms is recommended), and click .
4. Change directories set-up. Under "Setup Directories" in the workflow canvas there are seven parameters that specify important directories (green dots).

By default, the `ROOT_DATA_DIR`, which specifies the working directory within which the other directories are organised. is set to your `$HOME/reflex_data` directory. All the temporary and final products of the reduction will be organized under sub-directories of `ROOT_DATA_DIR`, therefore make sure this parameter points to a location where there is enough disk space. To change `ROOT_DATA_DIR`, double click on it and a pop-up window will appear allowing you to modify the directory string, which you may either edit directly, or use the  button to select the directory from a file browser. When you have finished, click  to save your changes.

Changing the value of `RAW_DATA_DIR` is the only necessary modification if you want to process data other than the demo data

5. Click the  button to start the workflow
6. The workflow will highlight the `Data Organiser` actor which recursively scans the raw data directory (specified by the parameter `RAW_DATA_DIR` under "Setup Directories" in the workflow canvas) and constructs the datasets. Note that the raw and static calibration data must be present either in `RAW_DATA_DIR` or in `CALIB_DATA_DIR`, otherwise datasets may be incomplete and cannot be processed. However, if the same reference file was downloaded twice to different places this creates a problem as `esoreflex` cannot decide which one to use.

- The `Data Set Chooser` actor will be highlighted next and will display a “Select Datasets” window that lists the datasets along with the values of a selection of useful header keywords<sup>2</sup>. The first column consists of a set of tick boxes which allow the user to select the datasets to be processed. By default all complete datasets which have not yet been reduced will be selected.
- Click the `Continue` button and watch the progress of the workflow by following the red highlighting of the actors. A window will show which dataset is currently being processed.
- Once the reduction of all datasets has finished, a pop-up window called *Product Explorer* will appear, showing the datasets which have been reduced together with the list of final products. This actor allows the user to inspect the final data products, as well as to search and inspect the input data used to create any of the products of the workflow.
- After the workflow has finished, all the products from all the datasets can be found in a directory under `END_PRODUCTS_DIR` named after the workflow start timestamp. Further subdirectories will be found with the name of each dataset.

Well done! You have successfully completed the quick start section and you should be able to use this knowledge to reduce your own data. However, there are many interesting features of `Reflex` and the `CRIRES+` workflow that merit a look at the rest of this tutorial.

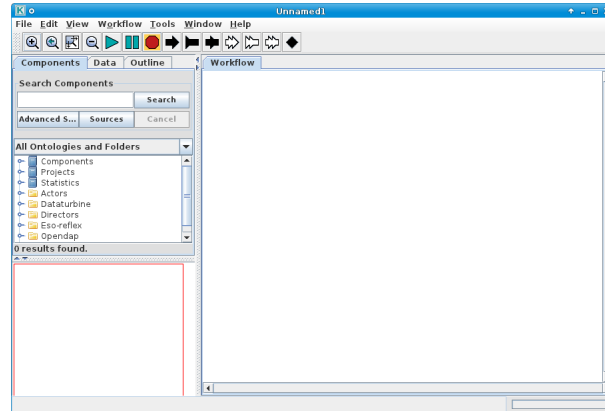

**Figure 3.3:** The empty `Reflex` canvas.

<sup>2</sup>The keywords listed can be changed by double clicking on the `DataOrganiser` Actor and editing the list of keywords in the second line of the pop-up window. Alternatively, instead of double-clicking, you can press the right mouse button on the `DataOrganiser` Actor and select `Configure Actor` to visualize the pop-up window.



## 4 The CRIRES+ Workflow

The CRIRES+ workflow canvas is organised into a number of areas. From top-left to top-right you will find general workflow instructions, directory parameters, and global parameters. In the middle row you will find five boxes describing the workflow general processing steps in order from left to right, and below this the workflow actors themselves are organised following the workflow general steps.

### 4.1 Workflow Canvas Parameters

The workflow canvas displays a number of parameters that may be set by the user. Under “Setup Directories” the user is only required to set the `RAW_DATA_DIR` to the working directory for the dataset(s) to be reduced, which, by default, is set to the directory containing the demo data. The `RAW_DATA_DIR` is recursively scanned by the `Data Organiser` actor for input raw data. The directory `CALIB_DATA_DIR`, which is by default within the pipeline installation directory, is also scanned by the `Data Organiser` actor to find any static calibrations that may be missing in your dataset(s). If required, the user may edit the directories `BOOKKEEPING_DIR`, `LOGS_DIR`, `TMP_PRODUCTS_DIR`, and `END_PRODUCTS_DIR`, which correspond to the directories where book-keeping files, logs, temporary products and end products are stored, respectively (see the Reflex User Manual for further details; [1]).

There is a mode of the `Data Organiser` that skips the built-in data organisation and uses instead the data organisation provided by the `CalSelector` tool. To use this mode, click on `Use CalSelector associations` in the `Data Organiser` properties and make sure that the input data directory contains the XML file downloaded with the `CalSelector` archive request (note that this does not work for all instrument workflows).

Under the “Global Parameters” area of the workflow canvas, the user may set the `FITS_VIEWER` parameter to the command used for running his/her favourite application for inspecting FITS files. Currently this is set by default to `fv`, but other applications, such as `ds9`, `skycat` and `gaia` for example, may be useful for inspecting image data. Note that it is recommended to specify the full path to the visualization application (an alias will not work).

By default the `EraseDirs` parameter is set to `false`, which means that no directories are cleaned before executing the workflow, and the recipe actors will work in Lazy Mode (see Section 5.4.2), reusing the previous pipeline recipe outputs if input files and parameters are the same as for the previous execution, which saves considerable processing time. Sometimes it is desirable to set the `EraseDirs` parameter to `true`, which forces the workflow to recursively delete the contents of the directories specified by `BOOKKEEPING_DIR`, `LOGS_DIR`, and `TMP_PRODUCTS_DIR`. This is useful for keeping disk space usage to a minimum and will force the workflow to fully re-reduce the data each time the workflow is run.

The parameter `RecipeFailureMode` controls the behaviour in case that a recipe fails. If set to `Continue`, the workflow will trigger the next recipes as usual, but without the output of the failing recipe, which in most of the cases will lead to further failures of other recipes without the user actually being aware of it. This mode might be useful for unattended processing of large number of datasets. If set to `Ask`, a pop-up window will ask whether the workflow should stop or continue. This is the default. Alternatively, the `Stop` mode will stop the workflow execution immediately.

The parameter `ProductExplorerMode` controls whether the `ProductExplorer` actor will show its window or not. The possible values are `Enabled`, `Triggered`, and `Disabled`. `Enabled` opens the Produc-



## CRIRES+ Reflex Tutorial

Doc. Number: ESO-413897  
Doc. Version: 1.6.13  
Released on: 2026-06-17  
Page: 16 of 25

---

tExplorer GUI at the end of the reduction of each individual dataset. `Triggered` (default and recommended) opens the ProductExplorer GUI when all the selected datasets have been reduced. `Disabled` does not display the ProductExplorer GUI.









## 5 About the main `esoreflex` canvas

### 5.1 Saving And Loading Workflows

In the course of your data reductions, it is likely that you will customise the workflow for various data sets, even if this simply consists of editing the `ROOT_DATA_DIR` to a different value for each data set. Whenever you modify a workflow in any way, you have the option of saving the modified version to an XML file using `File -> Export As` (which will also open a new workflow canvas corresponding to the saved file). The saved workflow may be opened in subsequent `esoreflex` sessions using `File -> Open`. Saving the workflow in the default Kepler format (`.kar`) is only advised if you do not plan to use the workflow with another computer.







### 5.2 Buttons

At the top of the `esoreflex` canvas are a set of buttons which have the following functions:

-  - Zoom in.
-  - Reset the zoom to 100%.
-  - Zoom the workflow to fit the current window size (Recommended).
-  - Zoom out.
-  - Run (or resume) the workflow.
-  - Pause the workflow execution.
-  - Stop the workflow execution.

The remainder of the buttons (not shown here) are not relevant to the workflow execution.





### 5.3 Workflow States

A workflow may only be in one of three states: executing, paused, or stopped. These states are indicated by the yellow highlighting of the , , and  buttons, respectively. A workflow is executed by clicking the  button. Subsequently the workflow and any running pipeline recipe may be stopped immediately by clicking the  button, or the workflow may be paused by clicking the  button which will allow the current actor/recipe to finish execution before the workflow is actually paused. After pausing, the workflow may be resumed by clicking the  button again.

## 5.4 Workflow Actors

### 5.4.1 Simple Actors

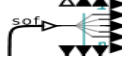
Simple actors have workflow symbols that consist of a single (rather than multiple) green-blue rectangle. They may also have an icon within the rectangle to aid in their identification. The following actors are simple actors:

-  - The `DataOrganiser` actor.
-  - The `DataSetChooser` actor (inside a composite actor).
-  - The `FitsRouter` actor Redirects files according to their categories.
-  - The `ProductRenamer` actor.
-  - The `ProductExplorer` actor (inside a composite actor).

Access to the parameters for a simple actor is achieved by right-clicking on the actor and selecting `Configure Actor`. This will open an “Edit parameters” window. Note that the `Product Renamer` actor is a jython script (Java implementation of the Python interpreter) meant to be customised by the user (by double-clicking on it).

There are no composite actors in the current workflow and each box corresponds to a single recipe call.

### 5.4.2 Lazy Mode

By default, all `RecipeExecutor` actors in a pipeline workflow are “Lazy Mode” enabled. This means that when the workflow attempts to execute such an actor, the actor will check whether the relevant pipeline recipe has already been executed with the same input files and with the same recipe parameters. If this is the case, then the actor will not execute the pipeline recipe, and instead it will simply broadcast the previously generated products to the output port. The purpose of the Lazy Mode is therefore to minimise any reprocessing of data by avoiding data re-reduction where it is not necessary.

One should note that the actor’s Lazy Mode depends on the contents of the directory specified by the parameter `BOOKKEEPING_DIR` and the relevant FITS file checksums. Any modification to the directory contents and/or the file checksums will cause the corresponding actor to run the pipeline recipe again when executed, thereby re-reducing the input data.

The re-reduction of data at each execution may sometimes be desirable. To force a re-reduction of data for any single `RecipeExecutor` actor in the workflow, right-click the actor, select `Configure Actor`, and



uncheck the Lazy mode parameter tick-box in the “Edit parameters” window that is displayed. For many workflows the `RecipeExecuter` actors are actually found inside the composite actors in the top level workflow. To access such embedded `RecipeExecuter` actors you will first need to open the sub-workflow by right-clicking on the composite actor and then selecting `Open Actor`.

To force the re-reduction of all data in a workflow (i.e. to disable Lazy mode for the whole workflow), you must uncheck the Lazy mode for every single `RecipeExecuter` actor in the entire workflow. It is also possible to change the name of the bookkeeping directory, instead of modifying any of the Lazy mode parameters. This will also force a re-reduction of the given dataset(s). A new reduction will start (with the lazy mode still enabled), but the results of previous reduction will not be reused. Alternatively, if there is no need to keep any of the previously reduced data, one can simply set the `EraseDirs` parameter under the “Global Parameters” area of the workflow canvas to `true`. This will then remove all previous results that are stored in the bookkeeping, temporary, and log directories before processing the input data, in effect, starting a new clean data reduction and re-processing every input dataset. *Note: The option `EraseDirs = true` does not work in esoreflex version 2.9.x and makes the workflow to crash.*



## 6 Frequently Asked Questions

- **The error window fills the whole screen - how can I get to the `Continue`/`Stop` buttons?**

Press the `Alt` key together with your left mouse button to move the window upwards and to the left. At the bottom the `Continue`/`Stop` buttons will be visible. This bug is known but could not yet be fixed.

- **I tried to `Open` (or `Configure`) an `Actor` while the workflow is running and now it does not react any more. What should I do?**

This is a limitation of the underlying Kepler engine. The only way out is to kill the workflow externally. If you want to change anything while a workflow is running you first need to pause it.

- **After a successful reduction of a data set, I changed this data set in some way (e.g. modified or removed some files, or changed the rules of the Data Organizer). When I restart Reflex, the Data Set Chooser correctly displays my new data set, but marks it as “reduced ok”, even though it was never reduced before. What does this mean?**

The labels in the column “Reduced” of the Data Set Chooser mark each dataset with “OK”, “Failed” or “-”. These labels indicate whether a data set has previously successfully been reduced at least once, all previous reductions failed, or a reduction has never been tried respectively. Data sets are identified by their name, which is derived from the first science file within the data set. As long as the data set name is preserved (i.e. the first science file in a data set has not changed), the Data Organizer will consider it to be the same data set. The Data Organizer recognizes any previous reductions of data sets it considers to be the same as the current one, and labels the current data set with “OK” if any of them was successful, even if the previously reduced data set differs from the current one.

Note that the Product Explorer will list all the previous reductions of a particular data set only at the end of the reduction. This list might include successful and/or unsuccessful reduction runs with different parameters, or in your case with different input files. The important fact is that these are all reductions of data sets with the same first raw science file. By browsing through all reductions of a particular raw science file, the users can choose the one they want to use.

- **Where are my intermediate pipeline products?** Intermediate pipeline products are stored in the directory `<TMP_PRODUCTS_DIR>` (defined on the workflow canvas, under Setup Directories) and organised further in directories by pipeline recipe.
- **Can I use different sets of bias frames to calibrate my flat frames and science data?** Yes. In fact this is what is currently implemented in the workflow(s). Each file in a DataSet has a purpose attached to it ([1]). It is this purpose that is used by the workflow to send the correct set of bias frames to the recipes for flat frame combination and science frame reduction, which may or may not be the same set of bias frames in each case.
- **Can I run Reflex from the command line?** Yes, use the command:

```
esoreflex -n <workflow_path>/<workflow>.xml
```

The `-n` option will set all the different options for Kepler and the workflows to avoid opening any GUI elements (including pipeline interactive windows).



It is possible to specify workflow variables (those that appear in the workflow canvas) in the command line. For instance, the raw data directory can be set with this command:

```
esoreflex -n -RAW_DATA_DIR <raw_data_path> \  
          <workflow_path>/<workflow>.xml
```

You can see all the command line options with the command `esoreflex -h`.

Note that this mode is not fully supported, and the user should be aware that the path to the workflow must be absolute and even if no GUI elements are shown, it still requires a connection to the window manager.

- **How can I add new actors to an existing workflow?** You can drag and drop the actors in the menu on the left of the Reflex canvas. Under `Eso-reflex -> Workflow` you may find all the actors relevant for pipeline workflows, with the exception of the recipe executer. This actor must be manually instantiated using `Tools -> Instantiate Component`. Fill in the "Class name" field with `org.eso.RecipeExecuter` and in the pop-up window choose the required recipe from the pull-down menu. To connect the ports of the actor, click on the source port, holding down the left mouse button, and release the mouse button over the destination port. Please consult the Reflex User Manual ([1]) for more information.
- **How can I broadcast a result to different subsequent actors?** If the output port is a multi-port (filled in white), then you may have several relations from the port. However, if the port is a single port (filled in black), then you may use the black diamond from the toolbar. Make a relation from the output port to the diamond. Then make relations from the input ports to the diamond. Please note that you cannot click to start a relation from the diamond itself. Please consult the Reflex User Manual ([1]) for more information.
- **How can I manually run the recipes executed by Reflex?** If a user wants to re-run a recipe on the command line he/she has to go to the appropriate `reflex_book_keeping` directory, which is generally `reflex_book_keeping/<workflow>/<recipe_name>_<number>`. There, subdirectories exist with the time stamp of the recipe execution (e.g. `2013-01-25T12:33:53.926/`). If the user wants to re-execute the most recent processing he/she should go to the `latest` directory and then execute the script `cmdline.sh`. Alternatively, to use a customized `esorex` command the user can execute

```
ESOREX_CONFIG="INSTALL_DIR/etc/esorex.rc"  
PATH_TO/esorex --recipe-config=<recipe>.rc <recipe> data.sof
```

where `INSTALL_DIR` is the directory where Reflex and the pipelines were installed.

If a user wants to re-execute on the command line a recipe that used a specific raw frame, the way to find the proper `data.sof` in the bookkeeping directory is via `grep <raw_file> */data.sof`. Afterwards the procedure is the same as before.

If a recipe is re-executed with the command explained above, the products will appear in the directory from which the recipe is called, and not in the `reflex_tmp_products` or `reflex_end_products` directory, and they will not be renamed. This does not happen if you use the `cmdline.sh` script.



- **Can I reuse the bookkeeping directory created by previous versions of the pipeline?**

In general no. In principle, it could be reused if no major changes were made to the pipeline. However there are situations in which a previously created bookkeeping directory will cause problems due to pipeline versions incompatibility. This is especially true if the parameters of the pipeline recipes have changed. In that case, please remove the bookkeeping directory completely.

- **How to insert negative values into a textbox?**

Due to a bug in wxPython, the GUI might appear to freeze when attempting to enter a negative number in a parameter's value textbox. This can be worked around by navigating away to a different control in the GUI with a mouse click, and then navigating back to the original textbox. Once focus is back on the original textbox the contents should be selected and it should be possible to replace it with a valid value, by typing it in and pressing the enter key.

- **I've updated my Reflex installation and when I run esoreflex the process aborts. How can I fix this problem?**

As indicated in Section 2, in case of major or minor (affecting the first two digit numbers) Reflex upgrades, the user should erase the `$HOME/KeplerData`, `$HOME/.kepler` directories if present, to prevent possible aborts (i.e. a hard crash) of the esoreflex process.

- **How can include my analysis scripts and algorithms into the workflow?**

EsoReflex is capable of executing any user-provided script, if properly interfaced. The most convenient way to do it is through the Python actor. Please consult the tutorial on how to insert Python scripts into a workflow available here: [www.eso.org/sci/data-processing/Python\\_and\\_esoreflex.pdf](http://www.eso.org/sci/data-processing/Python_and_esoreflex.pdf)

## 7 Troubleshooting

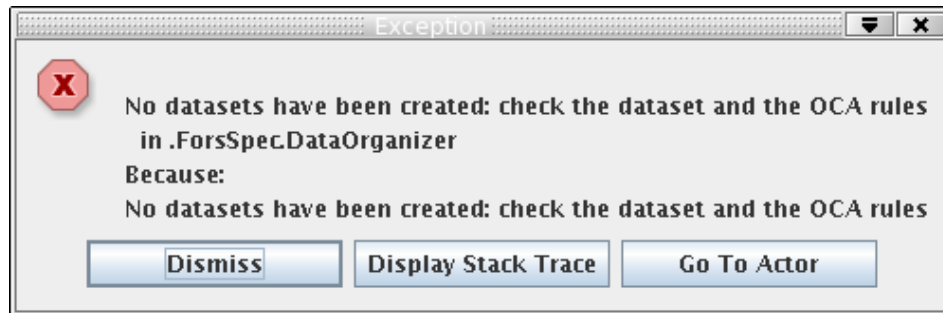

**Figure 7.1:** *TheDataOrganizer* interactive window reports an error “:No DataSets have been created, check the data set and the OCA rules.”.

1. I downloaded the data from the ESO archive, put them into a new directory, tried to run *Reflex* on them, but

(a) **it crashes**

The current release of the FORS pipeline includes some additional data in the static calibration frames. The recipes would choke if this data is not present. However, the ESO archive with CalSelector may associate calibration data which is old and *Reflex* will pick the files either from the installed pipeline static data or from the CalSelector in a non-deterministic way. In order to solve the issue, remove the static calibration data downloaded from the archive (all the files starting with M.FORS2).

This may happen if one of the files was downloaded only partially (check for a file with the extension `fits.Z.part`). You will have to download that file again in order to have an uncorrupted file (and remove the partial one).

(b) **The DataOrganiser fails with the error message “:No DataSets have been created, check the data set and the OCA rules.”(see Figure 7.1.)**

This error may be due to the fact that the data provided by the ESO archive are compressed (`<filename>.fits.Z`). Please remember to uncompress the data before running the workflow in *Reflex*.

Also, please remember that each CRIRES+ workflow supports only one mode. For example, if the data consists entirely of polarimetric observations, but any other workflow is executed, the Data Organiser actor will not construct any datasets, showing the mentioned error message.

2. **The “Select DataSets” window displays my datasets, but some/all of them are greyed out. What is going on?**

If a dataset in the “Select DataSets” window is greyed out, then it means that the dataset which was constructed is missing some key calibration(s) (i.e. the dataset is incomplete). To find out what calibration(s) are missing from a greyed out dataset, click on the dataset in question to highlight it in blue, and then



## CRIRES+ Reflex Tutorial

Doc. Number: ESO-413897  
Doc. Version: 1.6.13  
Released on: 2026-06-17  
Page: 24 of 25

---

click on the button `Inspect Highlighted`. The “Select Frames” window that appears will report the category of the calibration data that are missing (e.g. DARK). From this the user has then to determine the missing raw data (in this case bias frames). If static calibrations are missing the mechanism unfortunately does not work, but such data should be found by `reflex` in `<install_directory>/calib/<pipeline_version>/cal`



## CRIRES+ Reflex Tutorial

Doc. Number: ESO-413897  
Doc. Version: 1.6.13  
Released on: 2026-06-17  
Page: 25 of 25

---

- [1] Forchì V. *Reflex User's Manual*. ESO/SDD/DFS, <http://www.eso.org/reflex/>, 3.9 edition, 2018. VLT-MAN-ESO-19000-5037. 15, 20, 21